

QUICK START GUIDE AND USER MANUAL

IC282A

2-PORT USB 1.1 AND 2.0 CAT5E/6/7 EXTENDER

24/7 TECHNICAL SUPPORT AT 1.877.877.2269 OR VISIT BLACKBOX.COM



TABLE OF CONTENTS

QUICK START GUIDE.....	3
1. SPECIFICATIONS.....	5
2. OVERVIEW.....	6
2.1 Introduction.....	6
2.2 Features	
2.3 What's Included.....	6
2.4 Additional Items You Will Need.....	6
2.5 Hardware Description	7
2.5.1 Local Extender	7
2.5.2 Remote Extender	7
2.6 Typical Application.....	8
3. INSTALLATION	9
3.1 Preparing Your Site.....	9
3.2 Installing the Local Extender Unit.....	9
3.3 Installing the Remote Extender Unit.....	9
3.4 Connecting the Local Extender to the Remote Extender	9
3.4.1 With Surface Cabling.....	9
3.4.2 With Premise Cabling.....	9
3.5 Connecting USB Device(s).....	9
4. TROUBLESHOOTING.....	10
4.1 Problems/Solutions	10
4.2 Contacting Black Box.....	11
4.3 Shipping and Packaging.....	11
5. TECHNICAL GLOSSARY	12
APPENDIX A. REGULATORY INFORMATION	14
A.1 FCC Class B Statement	14
A.2 NOM Statement	15
APPENDIX B. DISCLAIMER/TRADEMARKS	16
B.1 Disclaimer	16
B.2 Trademarks Used in this Manual.....	16



Before you get started, make sure that all drivers required for your USB devices are installed.

1. Place the units where desired, and connect the CAT5e/6/7 (solid-core) extension link cabling to the link ports (RJ-45) on the Local Extender and the Remote Extender.

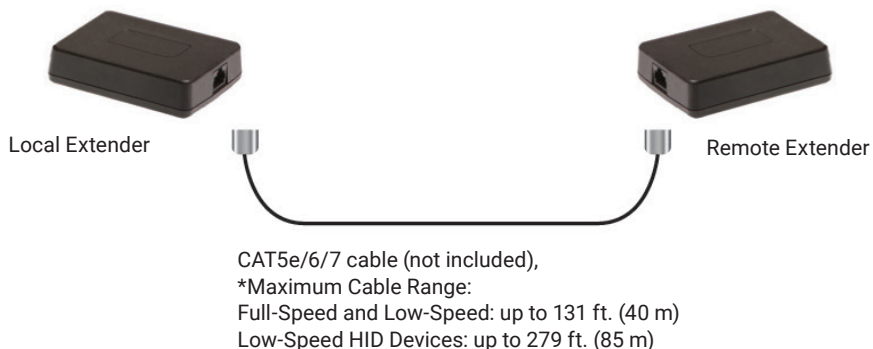

FIGURE QS-1. CONNECT THE LOCAL EXTENDER TO THE REMOTE EXTENDER

*NOTE: Up to 131 feet (40 m) for all USB devices; 278 feet (85 m) is achievable for most low powered HID USB devices

2. Connect the Local Extender to a computer with the included USB cable.

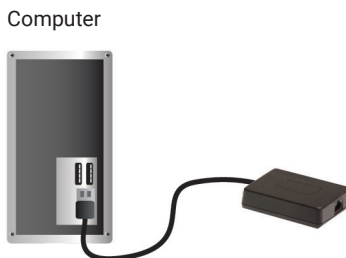

FIGURE QS-2. CONNECT THE LOCAL EXTENDER TO THE COMPUTER

3. Attach the USB device(s) to the Remote Extender.



FIGURE QS-3. CONNECT THE USB DEVICE(S) TO THE REMOTE EXTENDER

CHAPTER 1: SPECIFICATIONS

TABLE 1-1. SPECIFICATIONS

SPECIFICATION	DESCRIPTION
Approvals	FCC Class B, CE Class B, CES-003 Class B, ESD (EN61000) Criteria B, EFT (EN61000) Criteria B
Current	Maximum Current Available to Remote Extender is 400 mA when Local Extender is supplied with 800 mA
Distance (Maximum)	131 ft. (40 m) over solid-core CAT5e/6/7 cable NOTE: Up to 278 ft. (85 m) may be achieved with low-speed HID's such as keyboard and mouse.
Environmental	Operating Temperature: 32 to 122° F (0 to 50° C); Storage Temperature: -4 to +158° F (-20 to +70° C); Operating Humidity: 20 to 80% relative humidity, noncondensing; Storage Humidity: 10 to 90% relative humidity, noncondensing
USB Support	USB device: High-speed devices (USB 2.0) at full-speed (USB 1.1) rates, Full-speed devices (USB 2.0 and 1.1), Low-speed devices (USB 2.0 and 1.1); USB hub: Any single chain can include up to 3 USB hubs, depending on which USB devices are being extended. Extension distance will be reduced with each hub added to the system; USB host: XHCI (USB 3.0), EHCI (USB 2.0) and OHCI/UHCI (USB 1.1)
Connectors	Local Extender: (1) USB Type B, (1) RJ-45 (interconnect); Remote Extender: (2) USB Type A, (1) RJ-45 (interconnect)
Power	Remote Extender Unit: From the Local Extender; Available Power: 400mA shared between USB ports when transmitter (local extender) is supplied with 800 mA
Dimensions	Each unit (local or remote): 0.9" H x 3.3" W x 2.2" D (2.3 x 8.4 x 5.6 cm)
Weight	Both units: 0.212 lb. (0.0964 kg); Local unit: 0.100 lb. (0.045 kg); Remote unit: 0.112 lb. (0.050 kg)

CHAPTER 2: OVERVIEW

2.1 INTRODUCTION

Use CAT5e/6/7 cable to extend connections to USB peripherals such as keyboards, mice, interactive whiteboards, and other devices without the need for external power adapters. The extender is composed of two individual units: the local extender and the remote extender.

The local extender receives power from the host computer, making it ideal for extensions in industrial control, sensor, or data acquisition applications where you are short on power outlets. The extender supplies up to 400 mA to USB devices and is industrial rated for ESD/EFT (electrostatic discharge/electrically fast transient) immunity.

Also, the extender's remote unit has two downstream USB Type A ports for plugging in USB 1.1 or 2.0 devices. The extender supports 130-foot (40 m) extensions over non-networked CAT5e/6/7 cabling, but for some low-speed HID devices (keyboards and mice, for instance), it can go as far as 278 feet (85 m).

You don't need to add any software to your system or target devices. Simply attach the transmitter to your computer's USB port, plug in the CAT5e/6/7 cable, attach the remote USB peripheral to the receiver, and begin transmitting.

2.2 FEATURES

- ◆ Reliably extend USB 1.0 or 2.0 signaling over CAT5e/6/7 cable to remote USB devices
- ◆ Bus powered. No external AC adapter needed at either end
- ◆ Industrial rated for ESD immunity
- ◆ Supports both Full-Speed (12-Mbps) and Low-Speed (1.5-Mbps) throughput
- ◆ Works with all major operating systems (Windows®, MacOS™ X, and Linux®)
- ◆ Includes 6-foot (1.8-m) USB cable for transmitter-to-host computer connection
- ◆ Plug-and-play. No software drivers to load

2.3 WHAT'S INCLUDED

Your package should include the following items. If anything is missing or damaged, contact Black Box Technical Support at 877-877-2269 or info@blackbox.com.

- ◆ (1) Local Extender Unit
- ◆ (1) Remote Extender Unit
- ◆ (1) 6-ft. (1.8-m) USB 2.0 A-B cable

2.4 ADDITIONAL ITEMS YOU WILL NEED

To complete the installation, you will require the following items that are not included:

- ◆ USB compatible computer (host computer) with a USB compliant operating system
- ◆ USB devices
- ◆ CAT5e/6/7 Unshielded Twisted Pair (UTP) cable with two RJ-45 connectors (if using surface cabling), OR CAT5e/6/7 cabling with two information outlets and two CAT5e/6/7 patch cords with RJ-45 connectors (if using premise cabling)

NOTE: All references to CAT5e/6/7 cable in this document represent the minimum cable requirement of solid-core CAT5e/6/7 unshielded twisted-pair cable. Or, you can substitute CAT6 or better or STP cable.

2.5 HARDWARE DESCRIPTION

Figure 2-1 shows the side panels of the Local Extender Unit. Table 2-1 describes the local extender components. Figure 2-2 shows the side panels of the Remote Extender Unit. Table 2-2 describes the remote extender components.

2.5.1 LOCAL EXTENDER

The Local Extender connects to the host computer using the supplied USB A–B cable.

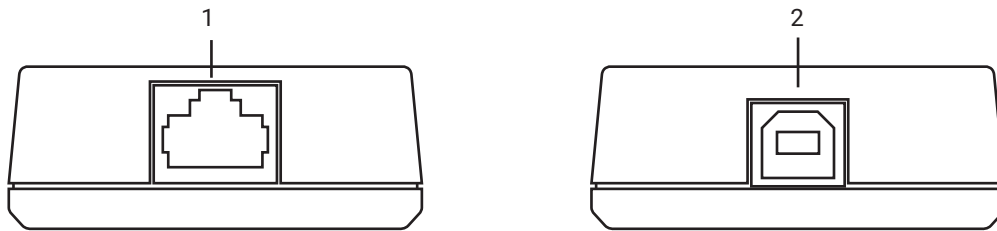

FIGURE 2-1. LOCAL EXTENDER

TABLE 2-1. LOCAL EXTENDER COMPONENTS

NUMBER IN FIGURE 2-1	COMPONENT	DESCRIPTION
1	Link port (RJ-45)	Accepts RJ-45 connector for CAT5e/6/7 cabling
2	Device port (USB Type B)	Used to connect the Local Extender unit to the host computer

2.5.2 REMOTE EXTENDER

The Remote Extender provides two downstream USB Type A ports for standard USB devices. Additional devices may be connected by attaching USB hubs.

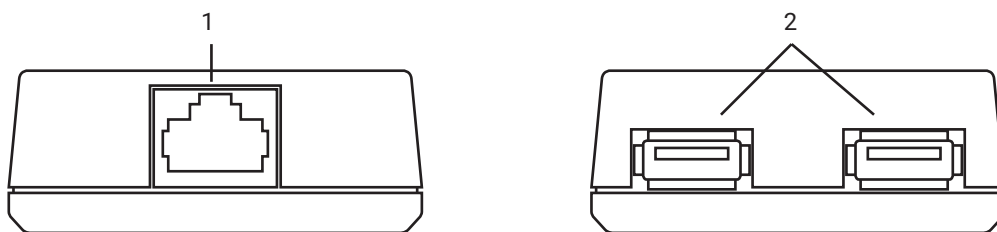

FIGURE 2-2. REMOTE EXTENDER

TABLE 2-2. REMOTE EXTENDER COMPONENTS

NUMBER IN FIGURE 2-2	COMPONENT	DESCRIPTION
1	Link port (RJ-45)	Accepts RJ-45 connector for CAT5e/6/7 cabling
2	(2) Device ports (USB Type A)	Accepts USB device(s)

CHAPTER 2: OVERVIEW

2.6 TYPICAL APPLICATION

Figure 2-3 shows a typical installation of the extender.

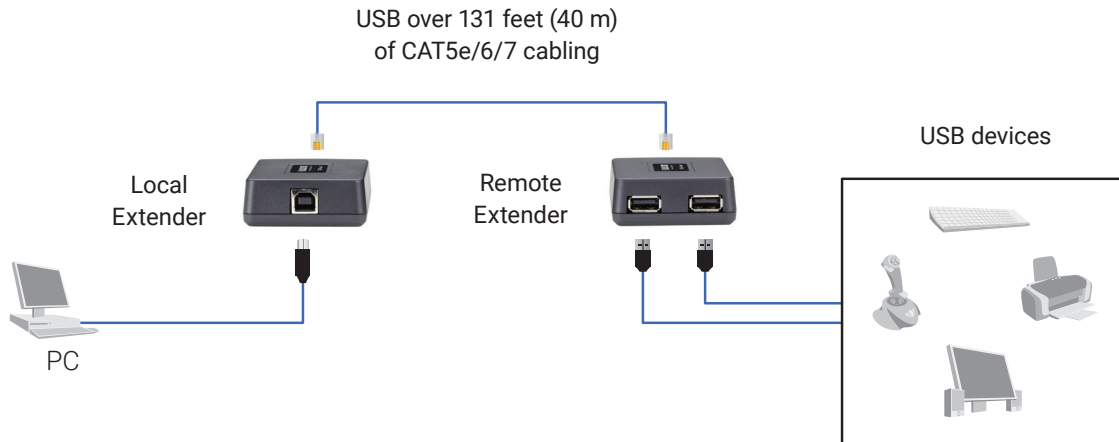

FIGURE 2-3. SAMPLE INSTALLATION

CHAPTER 3: INSTALLATION

3.1 PREPARING YOUR SITE

NOTE: The maximum extension length is reduced by 43.3 feet (13.2 m) for each USB hub added between the host computer and the end device.

NOTE: Extender systems cannot be daisychained. An extender system can have only one local extender and one remote extender.

Follow these steps to prepare your site:

1. Determine where the computer is to be located and set up the computer.
2. Determine where you want to locate the remote USB device(s).
3. Make sure the cable run (including patch cables) between the host computer and the USB device(s) is no greater than 131 feet (40 m).

3.2 INSTALLING THE LOCAL EXTENDER UNIT

1. Place the Local Extender unit near the computer.
2. Plug the USB cable from the Local Extender into an available USB 2.0/1.1 Type A Port on the computer.

3.3 INSTALLING THE REMOTE EXTENDER UNIT

1. Place the Remote Extender unit near the USB device(s) in the desired remote location.
2. Plug in your USB device(s).

3.4 CONNECTING THE LOCAL EXTENDER TO THE REMOTE EXTENDER

NOTE: Extension length is reduced for each USB hub added to the system. There is a 43.3-foot (13.2-meter) reduction in extension distance for each USB hub added to the system. This includes hubs added on the Local Extender or Remote Extender side.

NOTE: The Extender cannot be daisychained together. A system can have only one Local Extender and one Remote Extender.

3.4.1 WITH SURFACE CABLING

1. Plug one end of the CAT5e/6/7 cabling (not included) into the Link port (RJ-45) on the Local Extender unit.
2. Plug the other end of the CAT5e/6/7 cabling into the Link port (RJ-45) on the Remote Extender unit.

3.4.2 WITH PREMISE CABLING

1. Plug one end of a CAT5e/6/7 patch cord (not included) into the Link port (RJ-45) on the Local Extender unit.
2. Plug the other end of the patch cord into the CAT5e/6/7 information outlet near the host computer.
3. Plug one end of the second CAT5e/6/7 patch cord (not included) into the Link port (RJ-45) on the Remote Extender unit.
4. Plug the other end of the second patch cord into the CAT5e/6/7 information outlet near the USB device.

3.5 CONNECTING USB DEVICE(S)

1. Install any software required to operate the USB device(s). Refer to the documentation for the USB device(s), as required.
2. Connect the USB device(s) to the device port(s) on the Remote Extender unit.

CHAPTER 4: TROUBLESHOOTING

4.1 PROBLEMS/SOLUTIONS

This section provides troubleshooting tips. The topics are arranged in the order in which they should be executed, in most situations. If you are unable to resolve the problem after following these instructions, please contact Technical Support for further assistance.

Problem: The USB device does not operate correctly.

Possible Cause:

- ◆ The USB device is malfunctioning.
- ◆ The computer does not recognize the USB device.
- ◆ The application software for the device is not operating.
- ◆ The Extender is malfunctioning.

Solution:

1. Un-install and re-install the driver for the USB device.
2. Update the driver for the USB device.
3. Directly connect the USB device to the Host to verify the USB device operates correctly.
4. Contact Technical Support.

Problem: The USB device is detected as an “Unknown Device” in the Operating System.

Possible Cause:

- ◆ The USB device's timing is outside of the USB 1.1 specification.
- ◆ The Extender is malfunctioning.

Solution:

1. Connect the Remote Extender to the Local Extender using a patch cable.
2. Unplug the Local Extender from the host and wait 15 seconds. Then plug the Local Extender back into the host.
3. Contact Technical Support.

Problem:

The USB device is detected as using too much power in the Operating System.

Possible Cause:

- ◆ The USB device needs more power than the Extender can support.
- ◆ The Host is not providing enough power to the Extender.

Solution:

1. Connect the Local Extender to a different USB port on the Host.
2. Connect a self-powered USB hub between the Remote Extender and the USB device.



CHAPTER 4: TROUBLESHOOTING

4.2 CONTACTING BLACK BOX

If you determine that your 2-Port USB 1.1 and 2.0 CAT5e/6/7 Extender is malfunctioning, do not attempt to alter or repair the unit. It contains no user-serviceable parts. Contact Black Box Technical Support at 877-877-2269 or info@blackbox.com.

Before you do, make a record of the history of the problem. We will be able to provide more efficient and accurate assistance if you have a complete description, including:

- ♦ the nature and duration of the problem.
- ♦ when the problem occurs.
- ♦ the components involved in the problem.
- ♦ any particular application that, when used, appears to create the problem or make it worse.

4.3 SHIPPING AND PACKAGING

If you need to transport or ship your 2-Port USB 1.1 and 2.0 CAT5e/6/7 Extender:

- ♦ Package it carefully. We recommend that you use the original container.
- ♦ If you are returning the unit, make sure you include everything you received with it. Before you ship for return or repair, contact Black Box to get a Return Authorization (RA) number.

CHAPTER 5: TECHNICAL GLOSSARY

Category 5e/6/7 (CAT5e/6/7) Network Cabling – Category 5e/6/7 cable is commonly also referred to as CAT5e/6/7. This cabling is available in either solid or stranded twisted pair copper wire variants and as UTP (Unshielded Twisted Pair) or STP (Shielded Twisted Pair). UTP cables are not surrounded by any shielding, making them more susceptible to electromagnetic interference (EMI). STP cables include shielding over each individual pair of copper wires that provides better protection against EMI. Category 5 has been superseded by CAT5e cabling, which includes improved data integrity to support high-speed communications.

USB Cables – USB cables have two distinct connectors. The Type A connector is used to connect the cable from a USB device to the Type A port on a computer or hub. The Type B connector is used to attach the USB cable to a USB device.

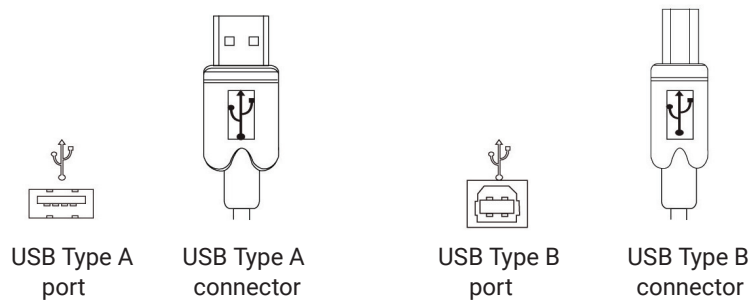

FIGURE 5-1. USB CABLES

CHAPTER 5: TECHNICAL GLOSSARY

RJ-45 – The Registered Jack (RJ) physical interface is what connects the network cabling (CAT5e/6/7) to the local extender and remote extender. You may use either the T568A scheme (Table 5-1, Figure 5-2) or the T568B scheme (Table 5-2, Figure 5-3) for cable termination because the extender uses all four pairs of the cable. RJ-45 connectors are sometimes also referred to as 8P8C connectors.

RJ-45 Pin Positioning –

TABLE 5-1. T568A WIRING

Pin	Pair	Wire	Cable Color
1	3	1	White/Green
2	3	2	Green
3	2	1	White/Orange
4	1	2	Blue
5	1	1	White/Blue
6	2	2	Orange
7	4	1	White/Brown
8	4	2	Brown

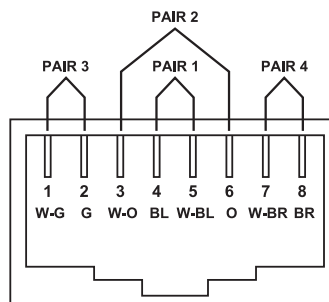

FIGURE 5-2. T568A CONNECTOR PINOUT

TABLE 5-2. T568B WIRING

Pin	Pair	Wire	Cable Color
1	2	1	White/Orange
2	2	2	Orange
3	3	1	White/Green
4	1	2	Blue
5	1	1	White/Blue
6	3	2	Green
7	4	1	White/Brown
8	4	2	Brown

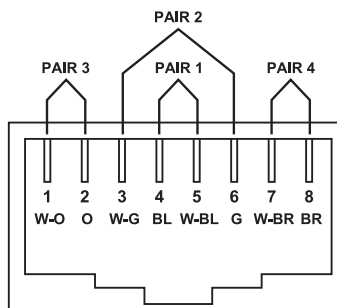

FIGURE 5-3. T568B CONNECTOR PINOUT

APPENDIX A: REGULATORY INFORMATION

A.1 FCC CLASS B STATEMENT

Class B Digital Device. This equipment has been tested and found to comply with the limits for a Class B computing device pursuant to Part 15 of the FCC Rules. These limits are designed to provide reasonable protection against harmful interference in a residential installation. However, there is no guarantee that interference will not occur in a particular installation. This equipment generates, uses, and can radiate radio frequency energy, and, if not installed and used in accordance with the instructions, may cause harmful interference to radio communications. If this equipment does cause harmful interference to radio or telephone reception, which can be determined by turning the equipment off and on, the user is encouraged to try to correct the interference by one of the following measures:

- ♦ Reorient or relocate the receiving antenna.
- ♦ Increase the separation between the equipment and receiver.
- ♦ Connect the equipment into an outlet on a circuit different from that to which the receiver is connected.
- ♦ Consult an experienced radio/TV technician for help.

CAUTION: Changes or modifications not expressly approved by the party responsible for compliance could void the user's authority to operate the equipment.

To meet FCC requirements, shielded cables and power cords are required to connect this device to a personal computer or other Class B certified device.

This digital apparatus does not exceed the Class B limits for radio noise emission from digital apparatus set out in the Radio Interference Regulation of Industry Canada.

Le présent appareil numérique n'émet pas de bruits radioélectriques dépassant les limites applicables aux appareils numériques de classe B prescrites dans le Règlement sur le brouillage radioélectrique publié par Industrie Canada.



APPENDIX A: REGULATORY INFORMATION

A.2 NOM STATEMENT

1. Todas las instrucciones de seguridad y operación deberán ser leídas antes de que el aparato eléctrico sea operado.
2. Las instrucciones de seguridad y operación deberán ser guardadas para referencia futura.
3. Todas las advertencias en el aparato eléctrico y en sus instrucciones de operación deben ser respetadas.
4. Todas las instrucciones de operación y uso deben ser seguidas.
5. El aparato eléctrico no deberá ser usado cerca del agua—por ejemplo, cerca de la tina de baño, lavabo, sótano mojado o cerca de una alberca, etc.
6. El aparato eléctrico debe ser usado únicamente con carritos o pedestales que sean recomendados por el fabricante.
7. El aparato eléctrico debe ser montado a la pared o al techo sólo como sea recomendado por el fabricante.
8. Servicio—El usuario no debe intentar dar servicio al equipo eléctrico más allá a lo descrito en las instrucciones de operación. Todo otro servicio deberá ser referido a personal de servicio calificado.
9. El aparato eléctrico debe ser situado de tal manera que su posición no interfiera su uso. La colocación del aparato eléctrico sobre una cama, sofá, alfombra o superficie similar puede bloquea la ventilación, no se debe colocar en libreros o gabinetes que impidan el flujo de aire por los orificios de ventilación.
10. El equipo eléctrico deber ser situado fuera del alcance de fuentes de calor como radiadores, registros de calor, estufas u otros aparatos (incluyendo amplificadores) que producen calor.
11. El aparato eléctrico deberá ser conectado a una fuente de poder sólo del tipo descrito en el instructivo de operación, o como se indique en el aparato.
12. Precaución debe ser tomada de tal manera que la tierra física y la polarización del equipo no sea eliminada.
13. Los cables de la fuente de poder deben ser guiados de tal manera que no sean pisados ni pellizcados por objetos colocados sobre o contra ellos, poniendo particular atención a los contactos y receptáculos donde salen del aparato.
14. El equipo eléctrico debe ser limpiado únicamente de acuerdo a las recomendaciones del fabricante.
15. En caso de existir, una antena externa deberá ser localizada lejos de las líneas de energía.
16. El cable de corriente deberá ser desconectado del cuando el equipo no sea usado por un largo periodo de tiempo.
17. Cuidado debe ser tomado de tal manera que objetos líquidos no sean derramados sobre la cubierta u orificios de ventilación.
18. Servicio por personal calificado deberá ser provisto cuando:
 - A: El cable de poder o el contacto ha sido dañado; u
 - B: Objetos han caído o líquido ha sido derramado dentro del aparato; o
 - C: El aparato ha sido expuesto a la lluvia; o
 - D: El aparato parece no operar normalmente o muestra un cambio en su desempeño; o
 - E: El aparato ha sido tirado o su cubierta ha sido dañada.

APPENDIX B: DISCLAIMER/TRADEMARKS

B.1 DISCLAIMER

Black Box Corporation shall not be liable for damages of any kind, including, but not limited to, punitive, consequential or cost of cover damages, resulting from any errors in the product information or specifications set forth in this document and Black Box Corporation may revise this document at any time without notice.

B.2 TRADEMARKS USED IN THIS MANUAL

Black Box and the Black Box logo type and mark are registered trademarks of Black Box Corporation.

Any other trademarks mentioned in this manual are acknowledged to be the property of the trademark owners.



NOTES

NEED HELP?
LEAVE THE TECH TO US
**LIVE 24/7
TECHNICAL
SUPPORT**
1.877.877.2269

A series of horizontal dashed lines for taking notes.

NOTES

NEED HELP?
LEAVE THE TECH TO US

**LIVE 24/7
TECHNICAL
SUPPORT**

1.877.877.2269

Lined area for notes.



**NEED HELP?
LEAVE THE TECH TO US**

**LIVE 24/7
TECHNICAL
SUPPORT**

1.877.877.2269

